

Zweigeteilte Lagergehäuse

■ Definition und Eigenschaften	644
■ Baureihen	645
■ Ausführungen	645
■ Berechnungsgrundlagen: Belastungen und Momente	646
■ Einbaurichtlinien: Dichtungsauswahl	647
■ Lagerdaten	648
<i>Stehlagergehäuse für Lager mit Spannhülsenbefestigung</i>	648
<i>Stehlagergehäuse für Lager mit zylindrischer Bohrung</i>	660



Definition und Eigenschaften

■ Die SNC-Stehlagergehäuse sind eine technologische Weiterentwicklung unserer bisherigen Baureihen SNB und SNU.

Die Hauptanschlussmaße der SNC-Baureihen entsprechen den Angaben der ISO 113/II: 1994 sowie DIN 736: 1984 bis DIN739: 1984.

Die Basis der Lagereinheiten bilden die zweiteiligen Gehäuse. Diese sind standardmäßig aus Grauguss nach DIN EN 1561 gefertigt und in verschiedenen Größen verfügbar. Für besonders hohe Beanspruchungen können auf Anfrage auch Gehäuse aus anderen Werkstoffen, wie zum Beispiel Sphäroguss, mit den gleichen Abmessungen gefertigt werden. Jedes einzelne Gehäuse kann Lager unterschiedlicher Innendurchmesser- und Breitenreihen aufnehmen. Dabei handelt es sich vorrangig um Pendelrollenlager.

Ausschlaggebend ist hierbei jedoch die Art der Anwendung. Werden z. B. hohe Drehzahlen gefordert, sind Pendelkugellager einsetzbar. Bei hohen Axial- und Radialkräften eignen sich Pendelrollenlager in besonderem Maße.

Zusammen mit den verschiedenen Dichtungselementen ergeben sich somit eine Vielzahl an Ausführungen, die das Standardprogramm von SNR umfasst. Die Wellendurchmesser liegen zwischen 20 und 160 mm (Sonderabmessungen auf Anfrage). Die Lager mit konischen Innenringen werden mit Hilfe einer Spannhülse auf der Welle befestigt. Lager mit zylindrischem Innenring sitzen dagegen direkt auf der Welle.

Die Abdichtungsmöglichkeiten der Gehäuse sind durch die große Anzahl der Einsatzfälle in der Praxis sehr unterschiedlich. Als wichtigste Faktoren sind hierbei die Drehzahlen und die äußeren Einflüsse, die auf die Einheit einwirken, zu nennen.

■ Zum SNR Standard-Programm gehören:

- Zweilippendichtung
- Filzstreifendichtung mit Dichtungsträger
- V-Ring-Dichtung mit Anlaufscheibe
- Labyrinthring-Dichtung
- Taconite-Dichtung

Alle SNC-Einheiten sind sowohl für durchgehende Wellen, als auch für Wellenenden konzipiert. Für diese Versionen ist ein Enddeckel erhältlich, der anstelle der Dichtung in die Dichtungsnut eingelegt wird.

Baureihen

■ Baureihe 500

Lagergehäuse für Wälzlager mit konischer Bohrung der Baureihen von 1200K bis 2200K, 22200K und 23200K
Wellendurchmesser: 20 - 140 mm

■ Baureihe 600

Lagergehäuse für Wälzlager mit konischer Bohrung der Baureihen 1300 K, 2300K, 21300K und 22300K
Wellendurchmesser: 20 - 90 mm

■ Baureihe 200

Lagergehäuse für Wälzlager mit zylindrischer Bohrung der Baureihen 1200, 2200, 22200 und 23200
Wellendurchmesser: 25 - 160 mm

■ Baureihe 300

Lagergehäuse für Wälzlager mit zylindrischer Bohrung Baureihen 1300, 2300, 21300 und 22300
Wellendurchmesser: 25 - 100 mm

Ausführungen

■ Festlager Ausführungen

Alle SNC-Gehäuse können durch Verwendung von Festtringen als Festlager verwendet werden. Festtringe müssen separat bestellt werden. Pro Gehäuse werden 2 Festtringe benötigt. Die entsprechenden Größen können den Maßtabellen entnommen werden.

■ Dichtungsvarianten

- ▶ **SC..DS** Zweilippendichtung
- ▶ **SC..FS** Filzstreifendichtung
- ▶ **SC..SV** V-Ring-Dichtung
- ▶ **SC..LA** Labyrinthdichtung
- ▶ **SC..TA** Taconite-Dichtung
- ▶ **V..A** V- Ring (A-Ausführung) zusätzlich zu SC...FS
- ▶ **SC..EC** Enddeckel

Bezeichnungsbeispiel:

SC518DS

Alle SNC-Einheiten sind sowohl für durchgehende Wellen als auch für Wellenendlagerungen konzipiert. Für diese Versionen ist ein Enddeckel (SC..EC) erhältlich. Dieser wird anstelle der zweiten Dichtung in die Nut zwischen Ober- und Unterteil eingelegt.

■ Komplettsysteme

SNR bietet seinen Kunden die Möglichkeit, anwendungsspezifische Komplettsysteme gemeinsam zu entwickeln und zu fertigen. Diese Lagerungssysteme können direkt in die Anwendungen integriert werden. Die Reduzierung der Kosten, insbesondere bei Serienproduktion, rechtfertigt den Einkauf von fertigen Systemlösungen. Logistische Abwicklungen werden vereinfacht und Inbetriebnahmezeiten verkürzt. Des Weiteren wird das Risiko von Montagefehlern vermieden.

Für die fachgerechte Montage und höchste Qualität der verwendeten Produkte stehen wir mit unserem Namen.

Profitieren Sie von unserem Service.



Berechnungsgrundlagen: Belastungen und Momente



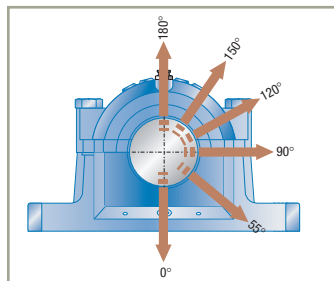







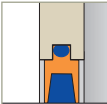
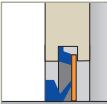
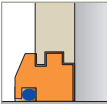
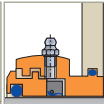







































Die nachfolgende Tabelle gibt Auskunft über die Bruchlasten von SNC-Lagergehäusen sowie die maximale Belastbarkeit der Verbindungsschrauben von Ober- und Unterteil und der Fußschrauben. In Abhängigkeit der Belastungsrichtungen und dem für die entsprechenden Betriebsbedingungen gewählten Sicherheitsfaktor können die zulässigen Belastungen ermittelt werden. Im Allgemeinen wird im Maschinenbau mit dem Sicherheitsfaktor 6 gerechnet. Die angegebenen Werte sind ausschließlich Richtwerte.



Gehäusegrößen SNC		Gehäusebruchlasten in Lastrichtung						Verbindungs- schrauben (Ober- /Unterteil) ⁽¹⁾ Festigkeits- klasse 8.8	Max. Belastbarkeit für beide Schrauben in Lastrichtung			Empfo- hlenes Anzieh- drehmo- ment Nm	Fuß- schrauben ⁽¹⁾ Festig- keits- klasse 8.8	Max. Anzieh- drehmo- ment Nm
		0°	55°	90°	120°	150°	180°		120°	150°	180°			
205	505	180	160	95	70	60	80	M10x40	60	35	30	65	M12	87
206	305 506 605	200	170	100	80	67	85	M10x40	60	35	30	65	M12	87
207	306 507 606	224	190	121	85	80	95	M10x45	60	35	30	65	M12	87
208	307 508 607	265	220	132	95	85	115	M12x50	80	45	40	65	M12	87
209	509	280	235	140	100	90	120	M12x55	80	45	40	65	M12	87
210	308 510 608	315	265	160	121	110	140	M12x55	80	45	40	65	M12	87
211	309 511 609	355	280	170	125	118	145	M16x60	180	100	90	150	M16	210
212	310 512 610	355	300	180	132	125	160	M16x60	180	100	90	150	M16	210
213	311 513 611	400	345	210	150	132	170	M16x70	180	100	90	150	M16	210
214		450	360	220	160	145	185	M16x70	180	100	90	150	M16	210
215	312 515 612	475	411	250	185	160	215	M16x70	180	100	90	150	M16	210
216	313 516 613	500	430	265	190	175	220	M16x80	180	100	90	290	M20	410
217	314 517	560	480	290	205	191	250	M16x80	180	100	90	290	M20	410
218	315 518 615	670	550	340	250	220	285	M20x90	260	150	130	290	M20	410
219	316 519 616	710	580	355	265	230	300	M20x100	260	150	130	290	M20	410
220	317 520 617	750	630	375	280	250	320	M24x100	360	210	180	500	M24	710
	318 618	800	670	400	315	280	340	M24x110	360	210	180	500	M24	710
222	319 522 619	950	800	450	355	320	400	M24x130	360	210	180	500	M24	710
224	320 524 620	950	800	475	355	320	420	M24x130	360	210	180	500	M24	710
226	526	1060	900	540	410	360	450	M24x130	360	210	180	500	M24	710
228	528	1250	1060	630	475	430	530	M24x140	360	210	180	1005	M30	1430
230	530	1400	1200	730	540	480	600	M24x150	360	210	180	1005	M30	1430
232	532	1700	1450	860	640	570	730	M30x160	730	430	360	1005	M30	1430

(1). ISO4014 (DIN EN 24014)

Einbaurichtlinien: Dichtungsauswahl

						
Konstruktive Eigenschaften		SC..DS	SC..FS	SC..SV	SC..LA	SC..TA
		Zweilippendichtung	Filzstreifendichtung	V-Ring Dichtung	Labyrinthdichtung	Taconite Dichtung
Einsatztemperatur	(°C)	-40...+100	-40...+100	-40...+100	-40...+200	-40...+100
Umfangsgeschwindigkeit	(m/s)	< 8	< 15	< 7 ⁽³⁾	> 15	< 10 ⁽⁴⁾
Mögliche Schiefstellung	(Grad)	0,5...1	< 0,5	1...1,5	< 0,3	< 0,5
Nachschmierbarkeit						
Geringe Reibung						
Loslagereignung						
Vertikaler Einbau						
Abdichtungsverhalten gegen:						
Spritzwasser / Feuchtigkeit						
Feinste Partikel						
Feine Partikel						
Grobe Partikel						
Scharfkantige Partikel						
UV-Beständigkeit						

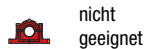

- (1) Während Einlaufphase bis ca. 5 m/s
- (2) Wenn V-Ring auf Unterseite innenliegend montiert ist.
- (3) Ohne zusätzlichen Stützung (mit axialer Sicherung: 7-12 m/s) ; mit axialer und radialer Sicherung >12 m/s)
- (4) Abhängig vom Wellendurchmesser

Stehlagergehäuse für Lager mit Spannhülzenbefestigung

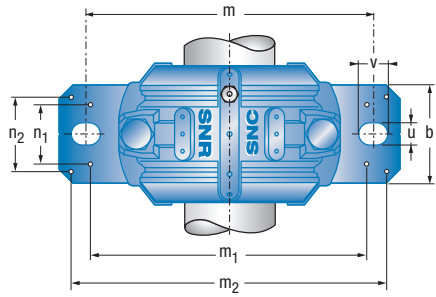
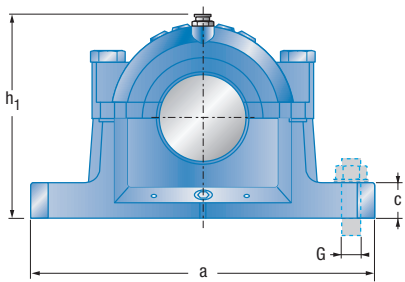

d	Typ	Gehäuse-Abmessungen															Gewicht ¹		
		D	a	b	c	g	h	l	m	G	u	v	h ₁	m ₁	n ₂	m ₂	n ₁	n ₃	≈
20	SNC505	52	165	46	19	25	40	67	130	M12	15	20	74	116	32	152	28	36	1,6
	SNC605	62	185	52	22	32	50	77	150	M12	15	20	89	130	38	172	25	44	2,3
25	SNC506	62	185	52	22	32	50	77	150	M12	15	20	89	130	38	172	25	44	2,3
	SNC606	72	185	52	22	34	50	82	150	M12	15	20	93	135	38	172	25	46	2,4
30	SNC507	72	185	52	22	34	50	82	150	M12	15	20	93	135	38	172	25	46	2,4
	SNC607	80	205	60	25	39	60	85	170	M12	15	20	107	160	44	188	34	50	3,2

1. Gehäusekörper

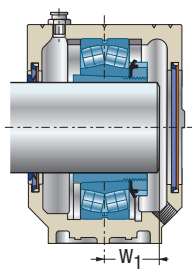

V-Ring
SC..SV + Enddeckel
SC..EC

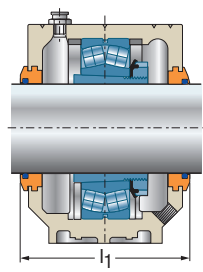

Labyrinthdichtung
SC..LA

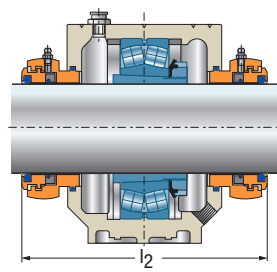

Taconite-Dichtung
SC..TA

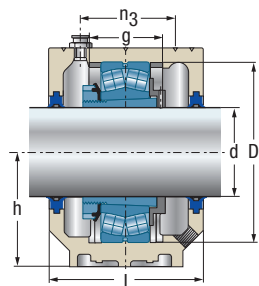

Zweilippendichtung
SC..DS + Reglerscheibe
RDC

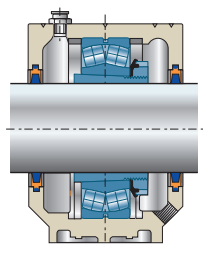

Filzstreifendichtung
SC..FS

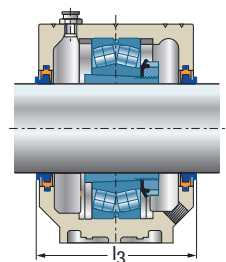

Filzstreifendichtung
SC..FS + V-Ring
V..A

Gehäuse	Dichtung ²	V-Ring ³	Enddeckel	w ₁	l ₁	l ₂	l ₃	Regler- scheibe	Wälz- lager	Festringe	
					mm				Spannhülse	2 St. je Gehäuse	
SNC505	SC505DS	V20A	SC505EC	18,0	79	134	85	RDC505	1205K	H205	FR52x5
	SC505FS			19,5					2205K	H305	FR52x3,5
	SC505SV			19,5					22205K	H305	FR52x3,5
	SC505LA										
	SC505TA										
SNC506-605	SC605DS	V20A	SC506-605EC	19,0	89	144	95	RDC605	1305K	H305	FR62x7,5
	SC605FS			22,5					2305K	H2305	FR62x4
	SC605SV			19,0					21305K	H305	FR62x7,5
	SC605LA										
	SC605TA										
SNC506-605	SC506DS	V25A	SC506-605EC	18,5	89	144	95	RDC506	1206K	H206	FR62x8
	SC506FS			20,5					2206K	H306	FR62x6
	SC506SV			20,5					22206K	H306	FR62x6
	SC506LA										
	SC506TA										
SNC507-606	SC606DS	V25A	SC507-606EC	20,0	94	148	100	RDC606	1306K	H306	FR72x7,5
	SC606FS			24,0					2306K	H2306	FR72x3,5
	SC606SV			20,0					21306K	H306	FR72x7,5
	SC606LA										
	SC606TA										
SNC507-606	SC507DS	V30A	SC507-606EC	20,0	94	148	100	RDC507	1207K	H207	FR72x8,5
	SC507FS			23,0					2207K	H307	FR72x5,5
	SC507SV			23,5					22207K	H307	FR72x5,5
	SC507LA										
	SC507TA										
SNC508-607	SC607DS	V30A	SC508-607EC	22,0	97	151	103	RDC607	1307K	H307	FR80x9
	SC607FS			27,0					2307K	H2307	FR80x4
	SC607SV			23,0					21307K	H307	FR80x8
	SC607LA										
	SC607TA										

2. Dichtungen sind pro Gehäuseseite zu bestellen

3. V-Ring optional für Filzstreifenabdichtung (FS) erhältlich.



Stehlagergehäuse für Lager mit Spannhülzenbefestigung (Fortsetzung)

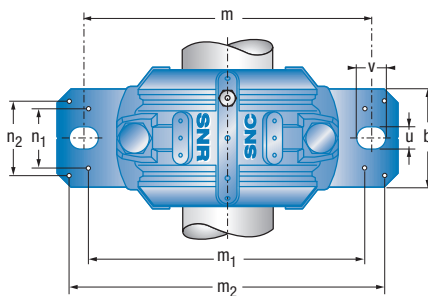
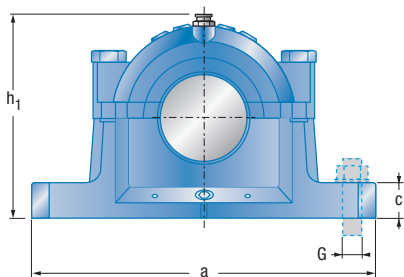

d	Typ	Gehäuse-Abmessungen															Gewicht ¹		
		D	a	b	c	g	h	l	m	G	u	v	h ₁	m ₁	n ₂	m ₂	n ₁	n ₃	≈
35	SNC508	80	205	60	25	39	60	85	170	M12	15	20	107	160	44	188	34	50	3,2
	SNC608	90	205	60	25	41	60	90	170	M12	15	20	113	160	44	188	34	53	3,4
40	SNC509	85	205	60	25	30	60	85	170	M12	15	20	110	160	44	188	34	44	3,2
	SNC609	100	255	70	28	44	70	95	210	M16	18	24	127	200	49	234	40	56	5,1
45	SNC510	90	205	60	25	41	60	90	170	M12	15	20	113	160	44	188	34	53	3,4
	SNC610	110	255	70	30	48	70	105	210	M16	18	24	133	200	54	234	40	64	5,4

1. Gehäusekörper

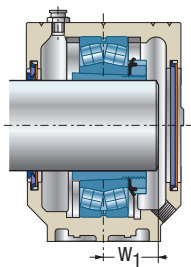

V-Ring
SC..SV + Enddeckel
SC..EC

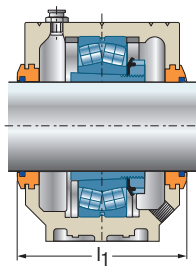

Labyrinthdichtung
SC..LA

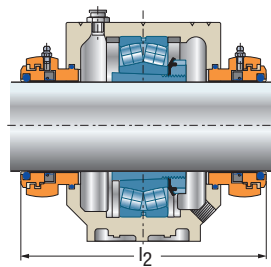

Taconite-Dichtung
SC..TA

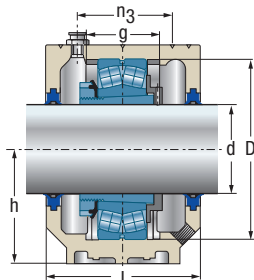

Zweilippendichtung
SC..DS + Reglerscheibe
RDC

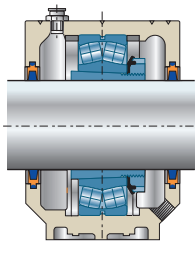

Filzstreifendichtung
SC..FS

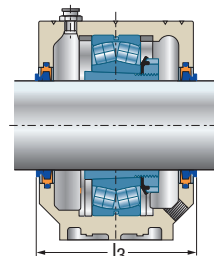

Filzstreifendichtung
SC..FS + V-Ring
V..A

Gehäuse	Dichtung ²	V-Ring ³	Enddeckel	w ₁	l ₁	l ₂	l ₃	Regler- scheibe	Wälzlager Spannhülse	Festringe 2 St. je Gehäuse	
SNC508-607	SC508DS	V35A	SC508-607EC	21,5	97	151	103	RDC508	1208K	H208	FR80x10,5
	SC508FS			24,0					2208K	H308	FR80x8
	SC508SV			24,0					22208K	H308	FR80x8
	SC508LA										
	SC508TA										
SNC510-608	SC608DS	V35A	SC510-608EC	24,0	102	154	108	RDC608	1308K	H308	FR90x9
	SC608FS			29,0					2308K	H2308	FR90x4
	SC608SV			24,0					21308K	H308	FR90x9
	SC608LA			29,0					22308K	H2308	FR90x4
	SC608TA										
SNC509	SC509DS	V40A	SC509EC	23,0	97	149	107	RDC509	1209K	H209	FR85x5,5
	SC509FS			25,0					2209K	H309	FR85x3,5
	SC509SV			25,0					22209K	H309	FR85x3,5
	SC509LA										
	SC509TA										
SNC511-609	SC609DS	V40A	SC511-609EC	26,0	107	158	117	RDC609	1309K	H309	FR100x9,5
	SC609FS			31,5					2309K	H2309	FR100x4
	SC609SV			26,0					21309K	H309	FR100x9,5
	SC609LA			31,5					22309K	H2309	FR100x4
	SC609TA										
SNC510-608	SC510DS	V45A	SC510-608EC	24,5	102	154	112	RDC510	1210K	H210	FR90x10,5
	SC510FS			26,0					2210K	H310	FR90x9
	SC510SV			26,0					22210K	H310	FR90x9
	SC510LA										
	SC510TA										
SNC512-610	SC610DS	V45A	SC512-610EC	28,0	117	168	127	RDC610	1310K	H310	FR110x10,5
	SC610FS			34,5					2310K	H2310	FR110x4
	SC610SV			28,0					21310K	H310	FR110x10,5
	SC610LA			34,5					22310K	H2310	FR110x4
	SC610TA										

2. Dichtungen sind pro Gehäuseseite zu bestellen

3. V-Ring optional für Filzstreifenabdichtung (FS) erhältlich.



Stehlagergehäuse für Lager mit Spannhülzenbefestigung (Fortsetzung)

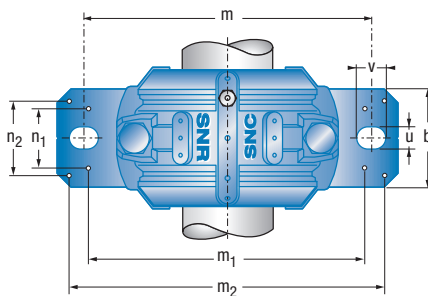
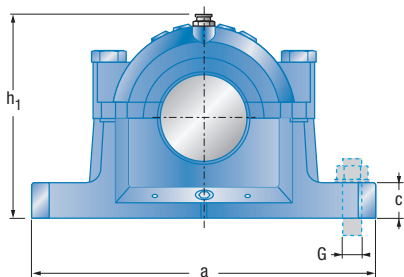

d	Typ	Gehäuse-Abmessungen															Gewicht ¹		
		D	a	b	c	g	h	l	m	G	u	v	h ₁	m ₁	n ₂	m ₂	n ₁	n ₃	≈
50	SNC511	100	255	70	28	44	70	95	210	M16	18	24	127	200	49	234	40	56	5,1
	SNC611	120	275	80	30	51	80	110	230	M16	18	24	148	220	58	252	48	63	7,0
55	SNC512	110	255	70	30	48	70	105	210	M16	18	24	133	200	54	234	40	64	5,4
	SNC612	130	280	80	30	56	80	115	230	M16	18	24	155	220	58	257	48	72	7,3
60	SNC513	120	275	80	30	51	80	110	230	M16	18	24	148	220	58	252	48	63	7,0
	SNC613	140	315	90	32	58	95	120	260	M20	22	28	175	252	66	288	52	72	10,4

1. Gehäusekörper

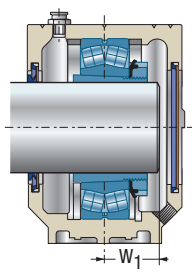

V-Ring
SC..SV + Enddeckel
SC..EC

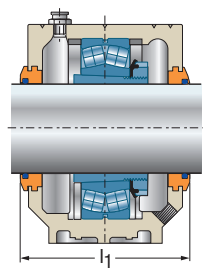

Labyrinthdichtung
SC..LA

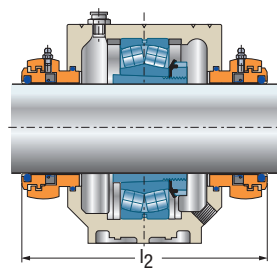

Taconite-Dichtung
SC..TA

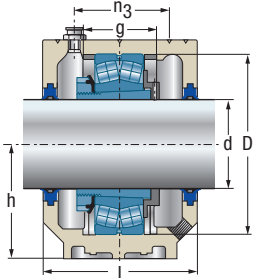

Zweilippendichtung
SC..DS + Reglerscheibe
RDC

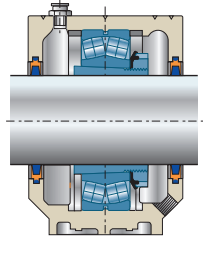

Filzstreifendichtung
SC..FS

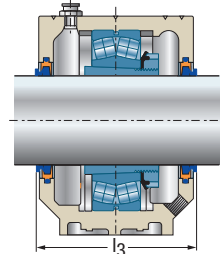

Filzstreifendichtung
SC..FS + V-Ring
V..A

Gehäuse	Dichtung ²	V-Ring ³	Enddeckel	w ₁	l ₁	l ₂	l ₃	Regler- scheibe	Wälz- lager	Festringe	
					mm				Spannhülse	2 St. je Gehäuse	
SNC511-609	SC511DS	V50A	SC511-609EC	25,5	107	158	117	RDC511	1211K	H211	FR100x11,5
	SC511FS			27,5					2211K	H311	FR100x9,5
	SC511SV			27,5					22211K	H311	FR100x9,5
	SC511LA										
	SC511TA										
SNC513-611	SC611DS	V50A	SC513-611EC	29,5	122	172	132	RDC611	1311K	H311	FR120x11
	SC611FS			36,5					2311K	H2311	FR120x4
	SC611SV			29,5					21311K	H311	FR120x11
	SC611LA			36,5					22311K	H2311	FR120x4
	SC611TA										
SNC512-610	SC512DS	V55A	SC512-610EC	26,5	117	168	127	RDC512	1212K	H212	FR110x13
	SC512FS			29,5					2212K	H312	FR110x10
	SC512SV			29,5					22212K	H312	FR110x10
	SC512LA										
	SC512TA										
SNC515-612	SC612DS	V55A	SC515-612EC	31,0	127	181	137	RDC612	1312K	H312	FR130x12,5
	SC612FS			38,5					2312K	H2312	FR130x5
	SC612SV			31,0					21312K	H312	FR130x12,5
	SC612LA			38,5					22312K	H2312	FR130x5
	SC612TA										
SNC513-611	SC513DS	V60A	SC513-611EC	28,0	122	172	132	RDC513	1213K	H213	FR120x14
	SC513FS			32,0					2213K	H313	FR120x10
	SC513SV			32,0					22213K	H313	FR120x10
	SC513LA										
	SC513TA										
SNC516-613	SC613DS	V60A	SC516-613EC	33,0	135	190	142	RDC613	1313K	H313	FR140x12,5
	SC613FS			40,5					2313K	H2313	FR140x5
	SC613SV			33,0					21313K	H313	FR140x12,5
	SC613LA			40,5					22313K	H2313	FR140x5
	SC613TA										

2. Dichtungen sind pro Gehäuseseite zu bestellen

3. V-Ring optional für Filzstreifenabdichtung (FS) erhältlich.



Stehlagergehäuse für Lager mit Spannhülzenbefestigung (Fortsetzung)

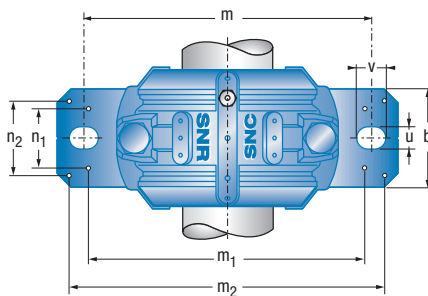
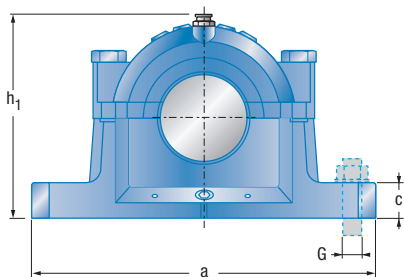

d	Typ	Gehäuse-Abmessungen															Gewicht ¹ ≈ [kg]		
		D	a	b	c	g	h	l	m	G	u	v	h ₁	m ₁	n ₂	m ₂		n ₁	n ₃
65	SNC515	130	280	80	30	56	80	115	230	M16	18	24	155	220	58	257	48	72	7,3
	SNC615	160	345	100	35	65	100	140	290	M20	22	28	192	280	74	319	58	80	13,5
70	SNC516	140	315	90	32	58	95	120	260	M20	22	28	175	252	66	288	52	72	10,4
	SNC616	170	345	100	35	68	112	145	290	M20	22	28	212	280	70	317	58	88	15,6
75	SNC517	150	320	90	32	61	95	125	260	M20	22	28	183	252	66	292	52	76	10,2
	SNC617	180	380	110	40	70	112	160	320	M24	26	32	215	300	78	348	66	104	18,4

1. Gehäusekörper

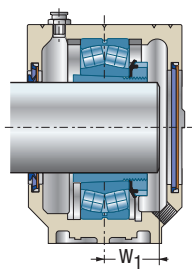

V-Ring
SC..SV + Enddeckel
SC..EC

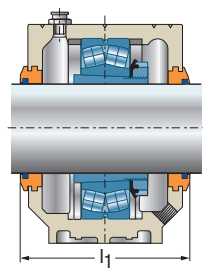

Labyrinthdichtung
SC..LA

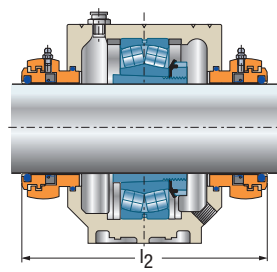

Taconite-Dichtung
SC..TA

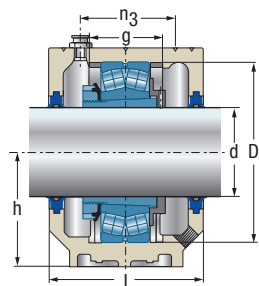

Zweilippendichtung
SC..DS + Reglerscheibe
RDC

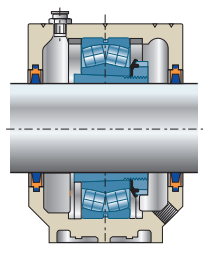

Filzstreifendichtung
SC..FS

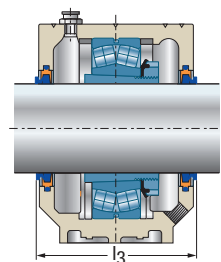

Filzstreifendichtung
SC..FS + V-Ring
V..A

Gehäuse	Dichtung ²	V-Ring ³	Enddeckel	w ₁	l ₁	l ₂	l ₃	Regler- scheibe	Wälz- lager Spannhülse	Festringe 2 St. je Gehäuse	
SNC515-612	SC515DS	V65A	SC515-612EC	30,0	127	181	137	RDC515	1215K	H215	FR130x15,5
	SC515FS			33,0					2215K	H315	FR130x12,5
	SC515SV			33,0					22215K	H315	FR130x12,5
	SC515LA										
	SC515TA										
SNC518-615	SC615DS	V65A	SC518-615EC	36,0	155	216	162	RDC615	1315K	H315	FR160x14
	SC615FS			45,0					2315K	H2315	FR160x5
	SC615SV			36,0					21315K	H315	FR160x14
	SC615LA			45,0					22315K	H2315	FR160x5
	SC615TA										
SNC516-613	SC516DS	V70A	SC516-613EC	32,5	135	190	147	RDC516	1216K	H216	FR140x16
	SC516FS			36,0					2216K	H316	FR140x12,5
	SC516SV			36,0					22216K	H316	FR140x12,5
	SC516LA										
	SC516TA										
SNC519-616	SC616DS	V70A	SC519-616EC	39,0	159	212	172	RDC616	1316K	H316	FR170x14,5
	SC616FS			48,5					2316K	H2316	FR170x5
	SC616SV			39,0					21316K	H316	FR170x14,5
	SC616LA			48,5					22316K	H2316	FR170x5
	SC616TA										
SNC517	SC517DS	V75A	SC517EC	34,5	140	201	152	RDC517	1217K	H217	FR150x16,5
	SC517FS			38,5					2217K	H317	FR150x12,5
	SC517SV			38,5					22217K	H317	FR150x12,5
	SC517LA										
	SC517TA										
SNC520-617	SC617DS	V75A	SC520-617EC	41,0	174	227	187	RDC617	1317K	H317	FR180x14,5
	SC617FS			50,5					2317K	H2317	FR180x5
	SC617SV			41,0					21317K	H317	FR180x14,5
	SC617LA			50,5					22317K	H2317	FR180x5
	SC617TA										

2. Dichtungen sind pro Gehäuseseite zu bestellen

3. V-Ring optional für Filzstreifenabdichtung (FS) erhältlich.



Stehlagergehäuse für Lager mit Spannhülzenbefestigung *(Fortsetzung)*

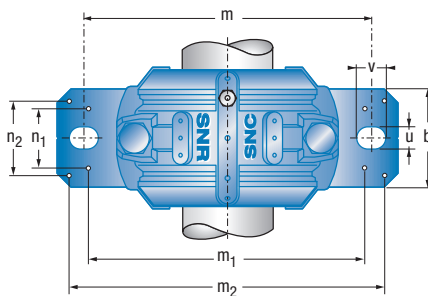
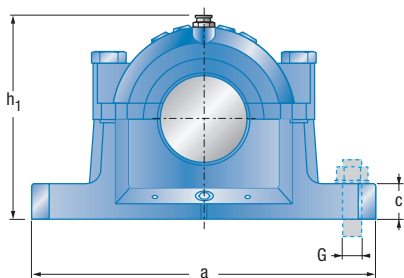

d	Typ	Gehäuse-Abmessungen															Gewicht ¹		
		D	a	b	c	g	h	l	m	G	u	v	h ₁	m ₁	n ₂	m ₂	n ₁	n ₃	≈
80	SNC518	160	345	100	35	65	100	140	290	M20	22	28	192	280	74	319	58	80	13,5
	SNC618	190	380	110	40	74	112	160	320	M24	26	32	220	300	78	348	66	104	18,5
85	SNC519	170	345	100	35	68	112	145	290	M20	22	28	212	280	70	317	58	88	15,6
	SNC619	200	410	120	45	80	125	175	350	M24	26	32	242	320	88	378	74	110	24,7
90	SNC520	180	380	110	40	70	112	160	320	M24	26	32	215	300	78	348	66	104	18,4
	SNC620	215	410	120	45	86	140	185	350	M24	26	32	271	330	88	378	74	122	30,0

1. Gehäusekörper

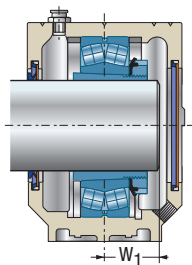

V-Ring
SC..SV + Enddeckel
SC..EC

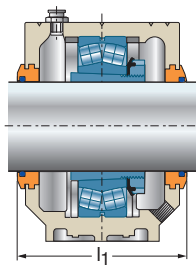

Labyrinthdichtung
SC..LA

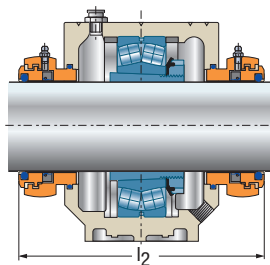

Taconite-Dichtung
SC..TA

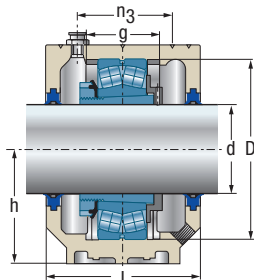

Zweilippendichtung
SC..DS + Reglerscheibe
RDC

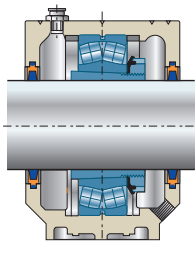

Filzstreifendichtung
SC..FS

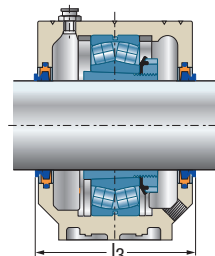

Filzstreifendichtung
SC..FS + V-Ring
V.A

Gehäuse	Dichtung ²	V-Ring ³	Enddeckel	w ₁	l ₁	l ₂	l ₃	Regler- scheibe	Wälz- lager	Festringe		
					mm				Spannhülse	2 St. je Gehäuse		
SNC518-615	SC518DS	V80A	SC518-615EC	35,5	155	216	167	RDC518	1218K	H218	FR160x17,5	
	SC518FS			40,5					2218K	H318	FR160x12,5	
	SC518SV			40,5					22218K	H318	FR160x12,5	
	SC518LA			46,8					23218K	H2318	FR160x6,25	
	SC518TA											
SNC318-618	SC618DS	V80A	SC318-618EC	42,0	172	227	187	RDC618	1318K	H318	FR190x15,5	
	SC618FS			52,5					2318K	H2318	FR190x5	
	SC618SV			42,0					21318K	H318	FR190x15,5	
	SC618LA			52,5					22318K	H2318	FR190x5	
	SC618TA											
SNC519-616	SC519DS	V85A	SC519-616EC	37,5	159	212	172	RDC519	1219K	H219	FR170x18	
	SC519FS			43,0					2219K	H319	FR170x12,5	
	SC519SV			43,0					22219K	H319	FR170x12,5	
	SC519LA											
	SC519TA											
SNC522-619	SC619DS	V85A	SC522-619EC	44,0	189	242	202	RDC619	1319K	H319	FR200x17,5	
	SC619FS			55,0					2319K	H2319	FR200x6,5	
	SC619SV			44,0					21319K	H319	FR200x17,5	
	SC619LA			55,0					22319K	H2319	FR200x6,5	
	SC619TA											
SNC520-617	SC520DS	V90A	SC520-617EC	39,5	174	227	187	RDC520	1220K	H220	FR180x18	
	SC520FS			45,5					2220K	H320	FR180x12	
	SC520SV			45,5					22220K	H320	FR180x12	
	SC520LA			52,7					23220K	H2320	FR180x4,85	
	SC520TA											
SNC524-620	SC620DS	V90A	SC524-620EC	46,0	199	249	212	RDC620	1320K	H320	FR215x19,5	
	SC620FS			59,0					2320K	H2320	FR215x6,5	
	SC620SV			46,0					21320K	H320	FR215x19,5	
	SC620LA			59,0					22320K	H2320	FR215x5	
	SC620TA											

2. Dichtungen sind pro Gehäuseseite zu bestellen

3. V-Ring optional für Filzstreifenabdichtung (FS) erhältlich.



Stehlagergehäuse für Lager mit Spannhülzenbefestigung (Fortsetzung)

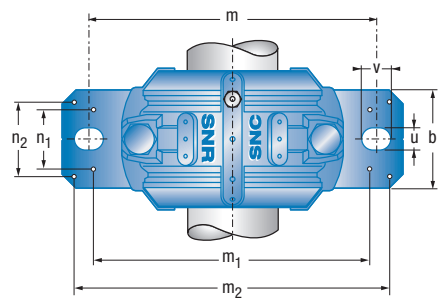
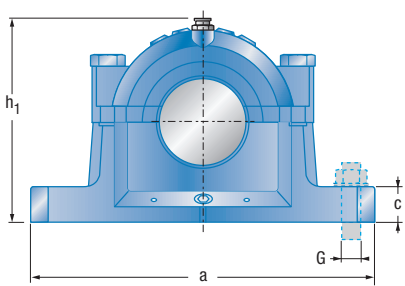

d	Typ	Gehäuse-Abmessungen															Gewicht ¹		
		D	a	b	c	g	h	l	m	G	u	v	h ₁	m ₁	n ₂	m ₂	n ₁	n ₃	≈
100	SNC522	200	410	120	45	80	125	175	350	M24	26	32	242	320	88	378	74	110	24,7
110	SNC524	215	410	120	45	86	140	185	350	M24	26	32	271	330	88	378	74	122	30,0
115	SNC526	230	445	130	50	90	150	190	380	M24	28	35	290	370	92	414	80	122	36,6
125	SNC528	250	500	150	50	98	150	205	420	M30	35	42	302	400	108	458	92	128	42,6
135	SNC530	270	530	160	60	106	160	220	450	M30	35	42	323	430	116	486	100	140	55,2
140	SNC532	290	550	160	60	114	170	235	470	M30	35	42	344	450	116	506	100	155	63,0

1. Gehäusekörper

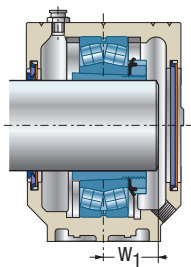

V-Ring
SC..SV + Enddeckel
SC..EC

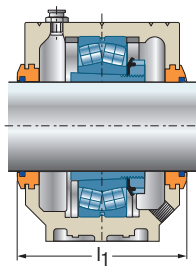

Labyrinthdichtung
SC..LA

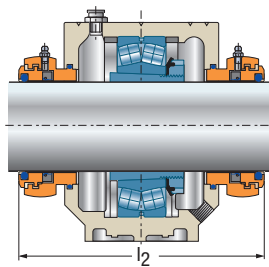

Taconite-Dichtung
SC..TA

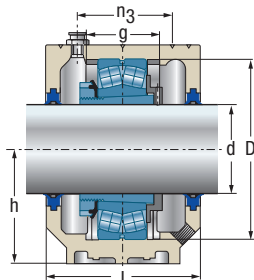

Zweilippendichtung
SC..DS + Reglerscheibe
RDC

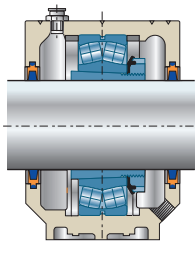

Filzstreifendichtung
SC..FS

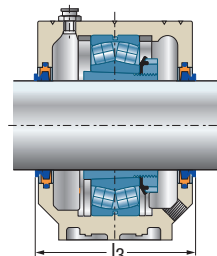

Filzstreifendichtung
SC..FS + V-Ring
V..A

Gehäuse	Dichtung ²	V-Ring ³	Enddeckel	w ₁	l ₁	l ₂	l ₃	Regler- scheibe	Wälzlager Spannhülse	Festringe 2 St. je Gehäuse		
				mm								
SNC522-619	SC522DS	V100A	SC522-619EC	42,5	189	242	202	RDC522	1222K	H222	FR200x21	
	SC522FS			50,0					2222K	H322	FR200x13,5	
	SC522SV			50,0					2222K	H322	FR200x13,5	
	SC522LA			58,4					2322K	H2322	FR200x5,1	
	SC522TA											
SNC524-620	SC524DS	V110A	SC524-620EC	53,5	199	249	216	RDC524	22224K	H3124	FR215x14	
	SC524FS			62,5					23224K	H2324	FR215x5	
	SC524SV											
	SC524LA											
	SC524TA											
SNC226-526	SC526DS	V120A	SC226-526EC	57,5	207	259	221	RDC526	22226K	H3126	FR230x13	
	SC526FS			65,5					23226K	H2326	FR230x5	
	SC526SV											
	SC526LA											
	SC526TA											
SNC228-528	SC528DS	V130A	SC228-528EC	60,5	222	275	236	RDC528	22228K	H3128	FR250x15	
	SC528FS			70,5					23228K	H2328	FR250x5	
	SC528SV											
	SC528LA											
	SC528TA											
SNC230-530	SC530DS	V140A	SC230-530EC	65,0	236	294	251	RDC530	22230K	H3130	FR270x16,5	
	SC530FS			76,5					23230K	H2330	FR270x5	
	SC530SV											
	SC530LA											
	SC530TA											
SNC232-532	SC532DS	V140A	SC232-532EC	70,5	254	309	256	RDC532	22232K	H3132	FR290x17	
	SC532FS			82,5					23232K	H2332	FR290x5	
	SC532SV											
	SC532LA											
	SC532TA											

2. Dichtungen sind pro Gehäuseseite zu bestellen

3. V-Ring optional für Filzstreifenabdichtung (FS) erhältlich.



Stehlagergehäuse für Lager mit zylindrischer Bohrung

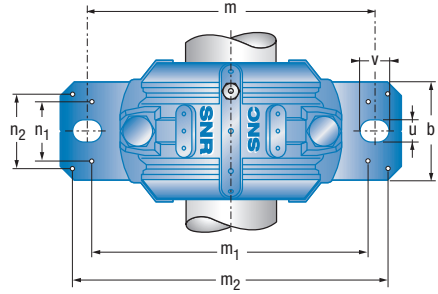
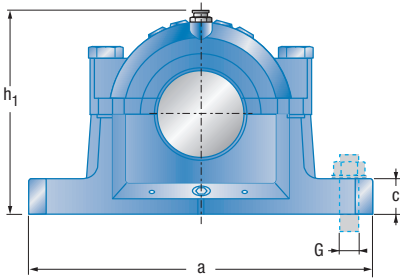

d	Typ	d ₁	D	Gehäuse-Abmessungen											Gewicht ¹								
				a	b	c	g	h	l	m	G	u	v	h ₁	m ₁	n ₁	m ₂	n ₂	n ₃	≈	[kg]		
																				[mm]			
25	SNC205	30	52	165	46	19	25	40	67	130	M12	15	20	74	116	32	152	28	36	1,5			
	SNC305	30	62	185	52	22	32	50	77	150	M12	15	20	89	130	38	172	25	44	2,1			
30	SNC206	35	62	185	52	22	32	50	77	150	M12	15	20	89	130	38	172	25	44	2,1			
	SNC306	35	72	185	52	22	34	50	82	150	M12	15	20	93	135	38	172	25	46	2,3			
35	SNC207	45	72	185	52	22	34	50	82	150	M12	15	20	93	135	38	172	25	46	2,3			
	SNC307	45	80	205	60	25	39	60	85	170	M12	15	20	107	160	44	188	34	50	3,1			

1. Gehäusekörper

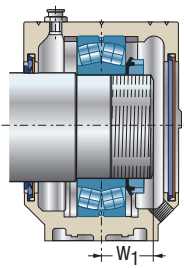

V-Ring
SC..SV + Enddeckel
SC..EC

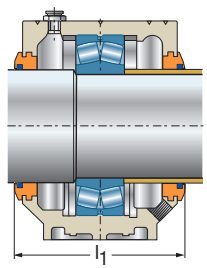

Labyrinthdichtung
SC..LA

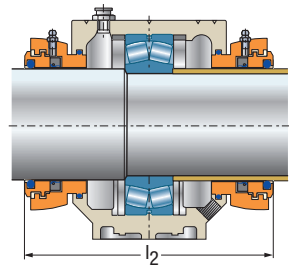

Taconite-Dichtung
SC..TA

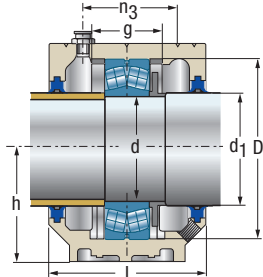

Zweilippendichtung
SC..DS + Reglerscheibe
RDC

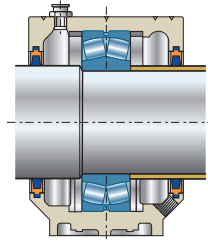

Filzstreifendichtung
SC..FS

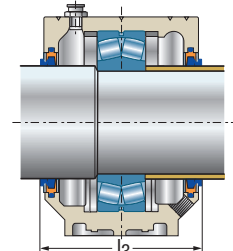

Filzstreifendichtung
SC..FS + V-Ring
V..A

Gehäuse	Dichtung ²	V-Ring ³	Enddeckel	Reglerscheibe				Festringe	
				w ₁	l ₁	l ₂	l ₃	Wälzlager	2 St. je Gehäuse
				[mm]					
SNC205	SC205DS	V30A	SC506-605EC	17	89	134	85	1205	FR52x5
	SC205FS			18,5				2205	FR52x3,5
	SC205SV			18,5				22205	FR52x3,5
	SC205LA								
	SC205TA								
SNC206-305	SC305DS	V30A	SC507-606EC	18	89	144	95	1305	FR62x7,5
	SC305FS			21,5				2305	FR62x4
	SC305SV			18				21305	FR62x7,5
	SC305LA								
	SC305TA								
SNC206-305	SC206DS	V35A	SC507-606EC	18,5	89	144	95	1206	FR62x8
	SC206FS			20,5				2206	FR62x6
	SC206SV			20,5				22206	FR62x6
	SC206LA								
	SC206TA								
SNC207-306	SC306DS	V35A	SC509EC	20	94	148	100	1306	FR72x7,5
	SC306FS			24				2306	FR72x3,5
	SC306SV			20				21306	FR72x7,5
	SC306LA								
	SC306TA								
SNC207-306	SC207DS	V45A	SC509EC	20	94	148	104	1207	FR72x8,5
	SC207FS			22				2207	FR72x5,5
	SC207SV			22,5				22207	FR72x5,5
	SC207LA								
	SC207TA								
SNC208-307	SC307DS	V45A	SC510-608EC	21	94	151	107	1307	FR80x9
	SC307FS			26				2307	FR80x4
	SC307SV			21				21307	FR80x9
	SC307LA								
	SC307TA								

2. Dichtungen sind pro Gehäuseseite zu bestellen

3. V-Ring optional für Filzstreifenabdichtung (FS) erhältlich.



Stehlagergehäuse für Lager mit zylindrischer Bohrung (Fortsetzung)

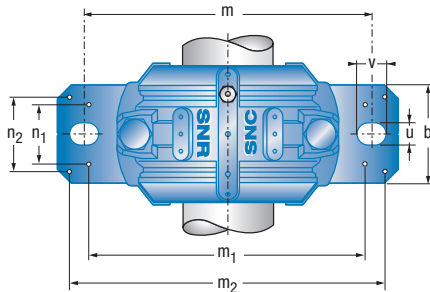
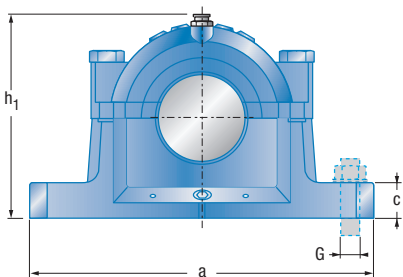

d	Typ	Gehäuse-Abmessungen															Gewicht ¹			
		d ₁	D	a	b	c	g	h	l	m	G	u	v	h ₁	m ₁	n ₁	m ₂	n ₂	n ₃	≈
40	SNC208	50	80	205	60	25	39	60	85	170	M12	15	20	107	160	44	188	34	50	3,1
	SNC308	50	90	205	60	25	41	60	90	170	M12	15	20	113	160	44	188	34	53	3,5
45	SNC209	55	85	205	60	25	30	60	85	170	M12	15	20	110	160	44	188	34	44	3,1
	SNC309	55	100	255	70	28	44	70	95	210	M16	18	24	127	200	49	234	40	56	5,0
50	SNC210	60	90	205	60	25	41	60	90	170	M12	15	20	113	160	44	188	34	53	3,5
	SNC310	60	110	255	70	30	48	70	105	210	M16	18	24	133	200	54	234	40	64	5,3

1. Gehäusekörper

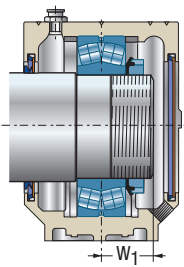

V-Ring
SC..SV + Enddeckel
SC..EC

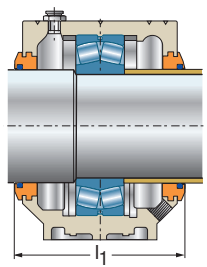

Labyrinthdichtung
SC..LA

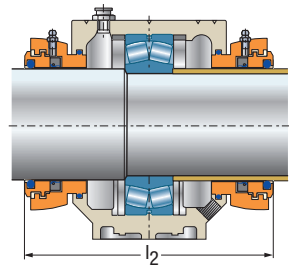

Taconite-Dichtung
SC..TA

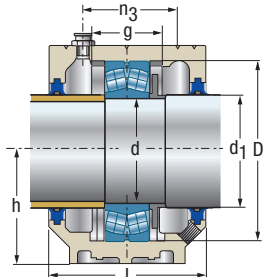

Zweilippendichtung
SC..DS + Reglerscheibe
RDC

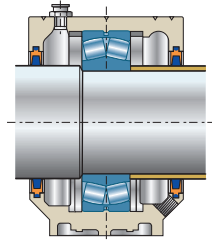

Filzstreifendichtung
SC..FS

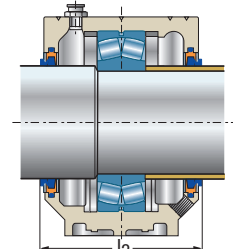

Filzstreifendichtung
SC..FS + V-Ring
V.A

Gehäuse	Dichtung ²	V-Ring ³	Enddeckel	Reglerscheibe				Festringe	
				w ₁	l ₁	l ₂	l ₃	Wälzlager	2 St. je Gehäuse
				[mm]					
SNC208-307	SC208DS	V50A	SC510-608EC	20,5	97	151	107	1208	FR80x10,5
	SC208FS			23				2208	FR80x8
	SC208SV			23				22208	FR80x8
	SC208LA								
	SC208TA								
SNC210-308	SC308DS	V50A	SC512-610EC	23	102	154	112	1308	FR90x9
	SC308FS			28				2308	FR90x4
	SC308SV			23				21308	FR90x9
	SC308LA			28				22308	FR90x4
	SC308TA								
SNC209	SC209DS	V55A	SC511-609EC	22	97	149	107	1209	FR85x5,5
	SC209FS			24				2209	FR85x3,5
	SC209SV			24				22209	FR85x3,5
	SC209LA								
	SC209TA								
SNC211-309	SC309DS	V55A	SC513-611EC	25	107	158	117	1309	FR100x9,5
	SC309FS			30,5				2309	FR100x4
	SC309SV			25				21309	FR100x9,5
	SC309LA			30,5				22309	FR100x4
	SC309TA								
SNC210-308	SC210DS	V60A	SC512-610EC	23,5	102	154	112	1210	FR90x10,5
	SC210FS			25				2210	FR90x9
	SC210SV			25				22210	FR90x9
	SC210LA								
	SC210TA								
SNC212-310	SC310DS	V60A	SC515-612EC	27	117	168	127	1310	FR110x10,5
	SC310FS			23,5				2310	FR110x4
	SC310SV			27				21310	FR110x10,5
	SC310LA			33,5				22310	FR110x4
	SC310TA								

2. Dichtungen sind pro Gehäuseseite zu bestellen

3. V-Ring optional für Filzstreifenabdichtung (FS) erhältlich.



Stehlagergehäuse für Lager mit zylindrischer Bohrung (Fortsetzung)

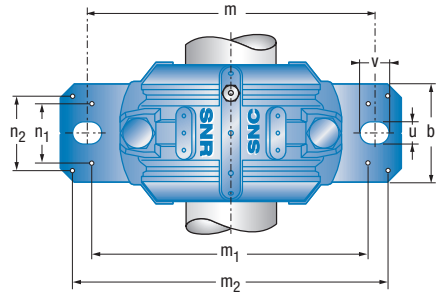
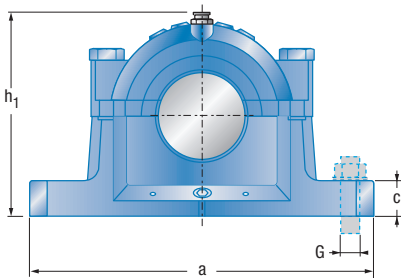

d	Typ	d ₁	D	Gehäuse-Abmessungen										Gewicht ¹⁾						
				a	b	c	g	h	l	m	G	u	v	h ₁	m ₁	n ₁	m ₂	n ₂	n ₃	≈
55	SNC211	65	100	255	70	28	44	70	95	210	M16	18	24	127	200	49	234	40	56	5,0
	SNC311	65	120	275	80	30	51	80	110	230	M16	18	24	148	220	58	252	48	63	6,7
60	SNC212	70	110	255	70	30	48	70	105	210	M16	18	24	133	200	54	234	40	64	5,3
	SNC312	70	130	280	80	30	56	80	115	230	M16	18	24	155	220	58	257	48	72	7,0
65	SNC213	75	120	275	80	30	51	80	110	230	M16	18	24	148	220	58	252	48	63	6,7
	SNC313	75	140	315	90	32	58	95	120	260	M20	22	28	175	252	66	288	52	72	9,5

1. Gehäusekörper

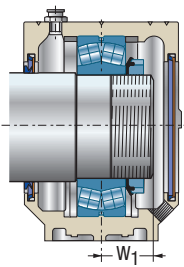

V-Ring
SC..SV + Enddeckel
SC..EC

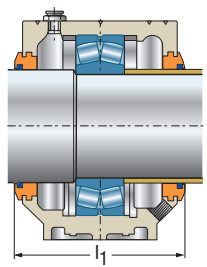

Labyrinthdichtung
SC..LA

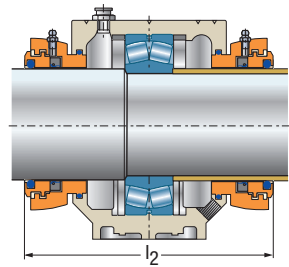

Taconite-Dichtung
SC..TA

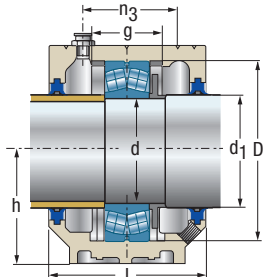

Zweilippendichtung
SC..DS + Reglerscheibe
RDC

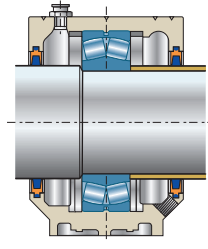

Filzstreifendichtung
SC..FS

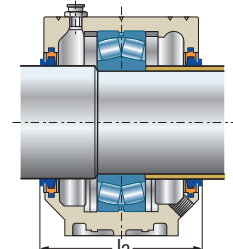

Filzstreifendichtung
SC..FS + V-Ring
V..A

Gehäuse	Dichtung ²	V-Ring ³	Enddeckel	w ₁	l ₁	l ₂	l ₃	Reglerscheibe		Festringe	
								Wälzlager	2 St. je Gehäuse		
SNC211-309	SC211DS	V65A	SC513-611EC	25	107	158	117	RDC211	1211	FR100x11,5	
	SC211FS			2211					FR100x9,5		
	SC211SV			22211					FR100x9,5		
	SC211LA										
	SC211TA										
SNC213-311	SC311DS	V65A	SC516-613EC	29	122	172	132	RDC311	1311	FR120x11	
	SC311FS			2311					FR120x4		
	SC311SV			21311					FR120x11		
	SC311LA			22311					FR120x4		
	SC311TA										
SNC212-310	SC212DS	V70A	SC515-612EC	26	119	168	132	RDC212	1212	FR110x13	
	SC212FS			2212					FR110x10		
	SC212SV			22212					FR110x10		
	SC212LA										
	SC212TA										
SNC215-312	SC312DS	V70A	SC518-615EC	30,5	130	181	142	RDC312	1312	FR130x12,5	
	SC312FS			2312					FR130x5		
	SC312SV			21312					FR130x12,5		
	SC312LA			22312					FR130x5		
	SC312TA										
SNC213-311	SC213DS	V80A	SC516-613EC	27	125	172	137	RDC213	1213	FR120x14	
	SC213FS			2213					FR120x10		
	SC213SV			22213					FR120x10		
	SC213LA										
	SC213TA										
SNC216-313	SC313DS	V75A	SC216-313EC	32	137	190	147	RDC313	1313	FR140x12,5	
	SC313FS			2313					FR140x5		
	SC313SV			21313					FR140x12,5		
	SC313LA			22313					FR140x5		
	SC313TA										

2. Dichtungen sind pro Gehäuseseite zu bestellen

3. V-Ring optional für Filzstreifenabdichtung (FS) erhältlich.



Stehlagergehäuse für Lager mit zylindrischer Bohrung (Fortsetzung)

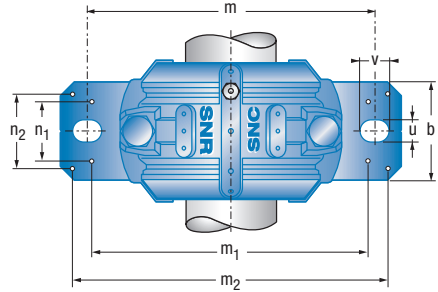
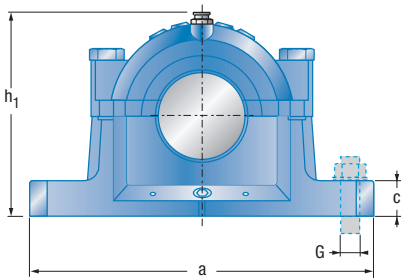

d	Typ	d ₁	D	Gehäuse-Abmessungen										Gewicht ¹						
				a	b	c	g	h	l	m	G	u	v	h ₁	m ₁	n ₁	m ₂	n ₂	n ₃	≈
70	SNC214	80	125	275	80	30	44	80	115	230	M16	18	23	154	220	58	252	48	66	7,6
	SNC314	80	150	320	90	32	61	95	125	260	M20	22	28	183	252	66	292	52	76	9,8
75	SNC215	85	130	280	80	30	56	80	115	230	M16	18	24	155	220	58	257	48	72	7,0
	SNC315	85	160	345	100	35	65	100	140	290	M20	22	28	192	280	74	319	58	80	12,4
80	SNC216	90	140	315	90	32	58	95	120	260	M20	22	28	175	252	66	288	52	72	9,5
	SNC316	90	170	345	100	35	68	112	145	290	M20	22	28	212	280	70	317	58	88	15,5

1. Gehäusekörper

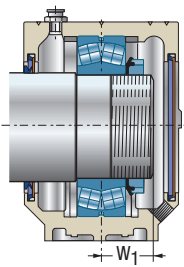

V-Ring
SC..SV + Enddeckel
SC..EC

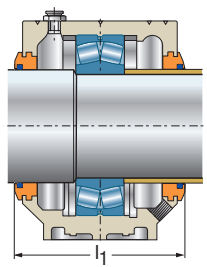

Labyrinthdichtung
SC..LA

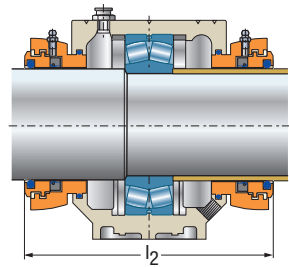

Taconite-Dichtung
SC..TA

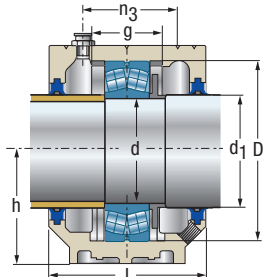

Zweilippendichtung
SC..DS + Reglerscheibe
RDC

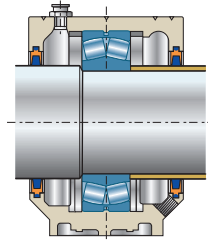

Filzstreifenabdichtung
SC..FS

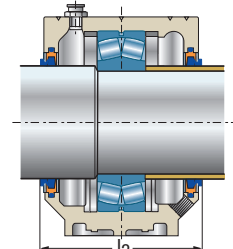

Filzstreifenabdichtung
SC..FS + V-Ring
V..A

Gehäuse	Dichtung ²	V-Ring ³	Enddeckel	Reglerscheibe				Festringe	
				w ₁	l ₁	l ₂	l ₃	Wälzlager	2 St. je Gehäuse
				[mm]					
SNC214	SC214DS	V80A	SC517EC	28,5	130	181	142	1214	FR125x10
	SC214FS			32				2214	FR125x6,5
	SC214SV			32				22214	FR125x6,5
	SC214LA								
	SC214TA								
SNC217-314	SC314DS	V80A	SC217-314EC	34	140	201	152	1314	FR150x13
	SC314FS			42				2314	FR150x5
	SC314SV			34				21314	FR150x13
	SC314LA			42				22314	FR150x5
	SC314TA								
SNC215-312	SC215DS	V85A	SC518-615EC	29	132	181	142	1215	FR130x15,5
	SC215FS			32				2215	FR130x12,5
	SC215SV			32				22215	FR130x12,5
	SC215LA								
	SC215TA								
SNC218-315	SC315DS	V85A	SC218-315EC	35	157	216	167	1315	FR160x14
	SC315FS			44				2315	FR160x5
	SC315SV			35				21315	FR160x14
	SC315LA			44				22315	FR160x5
	SC315TA								
SNC216-313	SC216DS	V90A	SC216-313EC	30,5	137	190	147	1216	FR140x16
	SC216FS			34				2216	FR140x12,5
	SC216SV			34				22216	FR140x12,5
	SC216LA								
	SC216TA								
SNC219-316	SC316DS	V90A	SC519-616EC	37	159	212	172	1316	FR170x14,5
	SC316FS			46,5				2316	FR170x5
	SC316SV			37				21316	FR170x14,5
	SC316LA			46,5				22316	FR170x5
	SC316TA								

2. Dichtungen sind pro Gehäuseseite zu bestellen

3. V-Ring optional für Filzstreifenabdichtung (FS) erhältlich.



Stehlagergehäuse für Lager mit zylindrischer Bohrung (Fortsetzung)

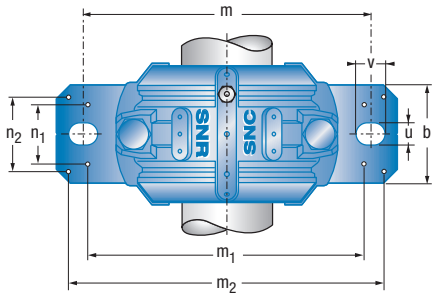
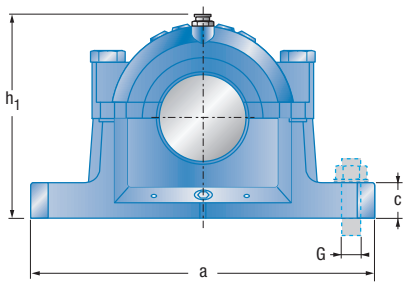

d	Typ	d ₁	D	Gehäuse-Abmessungen										Gewicht ¹						
				a	b	c	g	h	l	m	G	u	v	h ₁	m ₁	n ₁	m ₂	n ₂	n ₃	≈
85	SNC217	95	150	320	90	32	61	95	125	260	M20	22	28	183	252	66	292	52	76	9,8
	SNC317	95	180	380	110	40	70	112	160	320	M24	26	32	215	300	78	348	66	104	18,7
90	SNC218	100	160	345	100	35	65	100	140	290	M20	22	28	192	280	74	319	58	80	12,4
	SNC318	105	190	380	110	40	74	112	160	320	M24	26	32	220	300	78	348	66	104	18,5
95	SNC219	110	170	345	100	35	68	112	145	290	M20	22	28	212	280	70	317	58	88	15,5
	SNC319	110	200	410	120	45	80	125	175	350	M24	26	32	242	320	88	378	74	110	24,8

1. Gehäusekörper

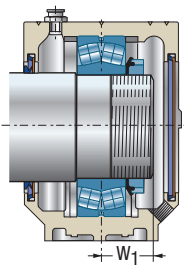

V-Ring
SC..SV + Enddeckel
SC..EC

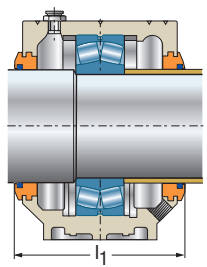

Labyrinthdichtung
SC..LA

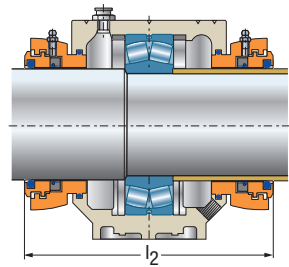

Taconite-Dichtung
SC..TA

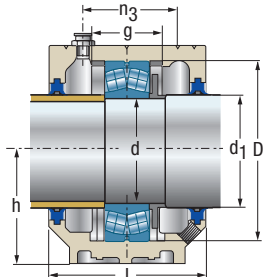

Zweilippendichtung
SC..DS + Reglerscheibe
RDC

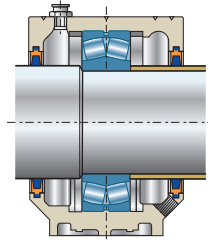

Filzstreifenabdichtung
SC..FS

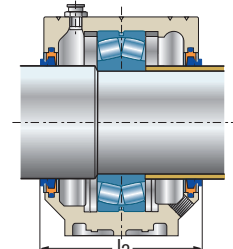

Filzstreifenabdichtung
SC..FS + V-Ring
V..A

Gehäuse	Dichtung ²	V-Ring ³	Enddeckel	Reglerscheibe				Festringe		
				w ₁	l ₁	l ₂	l ₃	Wälzlager	2 St. je Gehäuse	
				[mm]						
SNC217-314	SC217DS	V95A	SC217-314EC	33,5	142	201	152	1217	FR150x16,5	
	SC217FS			37,5				2217	FR150x12,5	
	SC217SV			37,5				22217	FR150x12,5	
	SC217LA									
	SC217TA									
SNC220-317	SC317DS	V95A	SC520-617EC	40	174	227	187	1317	FR180x14,5	
	SC317FS			49,5				2317	FR180x5	
	SC317SV			40				21317	FR180x14,5	
	SC317LA			49,5				22317	FR180x5	
	SC317TA									
SNC218-315	SC218DS	V100A	SC218-315EC	35,5	157	216	167	1218	FR160x17,5	
	SC218FS			40,5				2218	FR160x12,5	
	SC218SV			40,5				22218	FR160x12,5	
	SC218LA			46,8				23218	FR160x6,25	
	SC218TA									
SNC318-618	SC318DS	V110A	SC318-618EC	42	174	227	191	1318	FR190x15,5	
	SC318FS			52,5				2318	FR190x5	
	SC318SV			42				21318	FR190x15,5	
	SC318LA			52,5				22318	FR190x5	
	SC318TA									
SNC219-316	SC219DS	V110A	SC519-616EC	36,5	159	212	176	1219	FR170x18	
	SC219FS			42				2219	FR170x12,5	
	SC219SV			42				22219	FR170x12,5	
	SC219LA									
	SC219TA									
SNC222-319	SC319DS	V110A	SC522-619EC	43	189	242	206	1319	FR200x17,5	
	SC319FS			54				2319	FR200x6,5	
	SC319SV			43				21319	FR200x17,5	
	SC319LA			54				22319	FR200x6,5	
	SC319TA									

2. Dichtungen sind pro Gehäuseseite zu bestellen

3. V-Ring optional für Filzstreifenabdichtung (FS) erhältlich.



Stehlagergehäuse für Lager mit zylindrischer Bohrung (Fortsetzung)

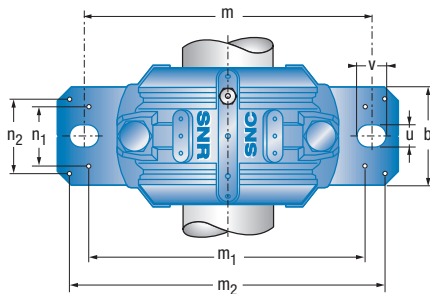
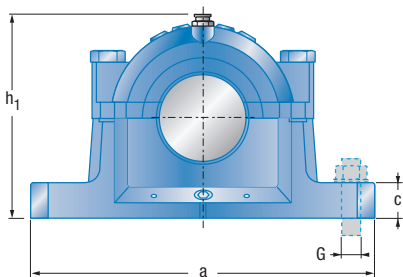

d	Typ	Gehäuse-Abmessungen														Gewicht ¹⁾				
		d ₁	D	a	b	c	g	h	l	m	G	u	v	h ₁	m ₁	n ₁	m ₂	n ₂	n ₃	≈
100	SNC220	115	180	380	110	40	70	112	160	320	M24	26	32	215	300	78	348	66	104	18,7
	SNC320	115	215	410	120	45	86	140	185	350	M24	26	32	271	330	88	378	74	122	30,4
110	SNC222	125	200	410	120	45	80	125	175	350	M24	26	32	242	320	88	378	74	110	24,8
120	SNC224	135	215	410	120	45	86	140	185	350	M24	26	32	271	330	88	378	74	122	30,4
130	SNC226	145	230	445	130	50	90	150	190	380	M24	28	35	290	370	92	414	80	122	36,6
140	SNC228	155	250	500	150	50	98	150	205	420	M30	35	42	302	400	108	458	92	128	42,5

1. Gehäusekörper

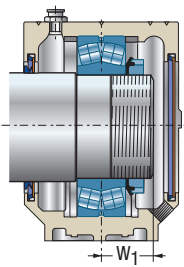

V-Ring
SC..SV + Enddeckel
SC..EC

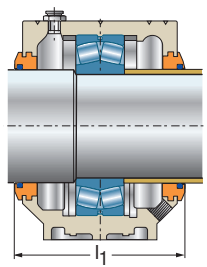

Labyrinthdichtung
SC..LA

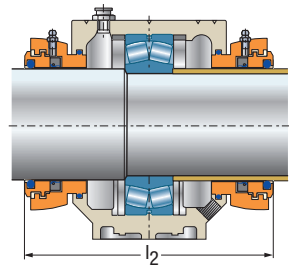

Taconite-Dichtung
SC..TA

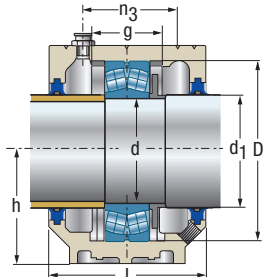

Zweilippendichtung
SC..DS + Reglerscheibe
RDC

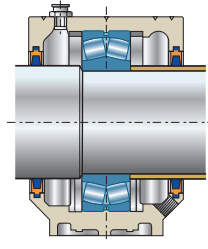

Filzstreifendichtung
SC..FS

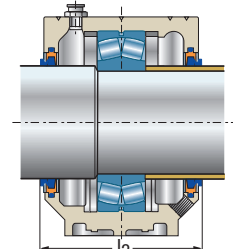

Filzstreifendichtung
SC..FS + V-Ring
V..A

Gehäuse	Dichtung ²	V-Ring ³	Enddeckel	Reglerscheibe				Festringe	
				w ₁	l ₁	l ₂	l ₃	Wälzlager	2 St. je Gehäuse
				[mm]					
SNC220-317	SC220DS	V120A	SC520-617EC	38,5	177	227	191	1220	FR180x18
	SC220FS			44,5				2220	FR180x12
	SC220SV			44,5				2220	FR180x12
	SC220LA			51,7				23220	FR180x4,85
	SC220TA								
SNC224-320	SC320DS	V120A	SC524-620EC	45,0	200	249	216	1320	FR215x19,5
	SC320FS			58,0				2320	FR215x6,5
	SC320SV			45,0				21320	FR215x19,5
	SC320LA			58,0				22320	FR215x6,5
	SC320TA								
SNC222-319	SC222DS	V130A	SC522-619EC	41,5	193	242	206	1222	FR200x21
	SC222FS			49,0				2222	FR200x13,5
	SC222SV			49,0				2222	FR200x13,5
	SC222LA			57,4				23222	FR200x5,1
	SC222TA								
SNC224-320	SC224DS	V140A	SC524-620EC	53,5	201	249	216	2224	FR215x14
	SC224FS			62,5				23224	FR215x5
	SC224SV								
	SC224LA								
	SC224TA								
SNC226-526	SC226DS	V150A	SC226-526EC	57,5	201	259	221	2226	FR230x13
	SC226FS			65,5				23226	FR230x5
	SC226SV								
	SC226LA								
	SC226TA								
SNC228-528	SC228DS	V160A	SC228-528EC	60,5	221	275	241	2228	FR250x15
	SC228FS			70,5				23228	FR250x5
	SC228SV								
	SC228LA								
	SC228TA								

2. Dichtungen sind pro Gehäuseseite zu bestellen

3. V-Ring optional für Filzstreifenabdichtung (FS) erhältlich.



Stehlagergehäuse für Lager mit zylindrischer Bohrung (Fortsetzung)

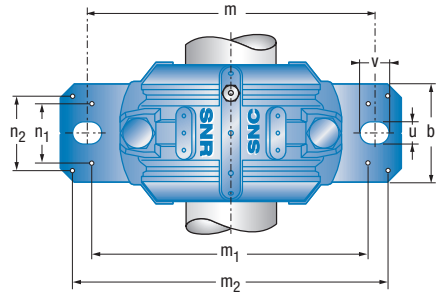
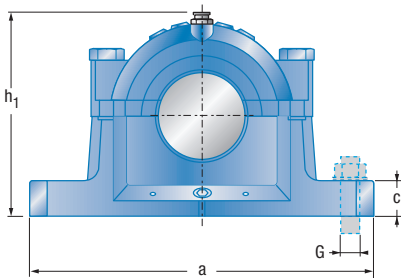

d	Typ	d ₁	D	Gehäuse-Abmessungen											Gewicht ¹					
				a	b	c	g	h	l	m	G	u	v	h ₁	m ₁	n ₁	m ₂	n ₂	n ₃	≈
[mm]																			[kg]	
150	SNC230	165	270	530	160	60	106	160	220	450	M30	35	42	323	430	116	486	10	140	55,2
160	SNC232	175	290	550	160	60	114	170	235	470	M30	35	42	344	450	116	506	100	155	63,0

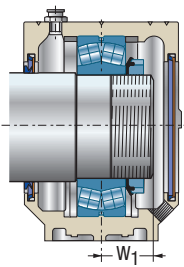

V-Ring
SC..SV + Enddeckel
SC..EC

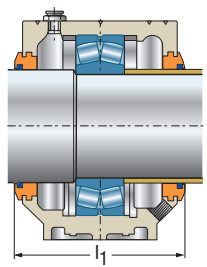

Labyrinthdichtung
SC..LA

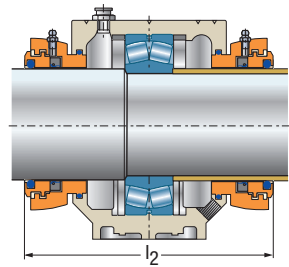

Taconite-Dichtung
SC..TA

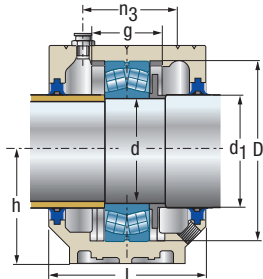

Zweilippendichtung
SC..DS + Reglerscheibe
RDC

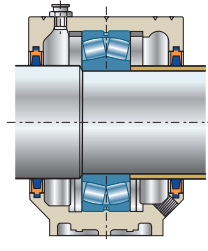

Filzstreifendichtung
SC..FS

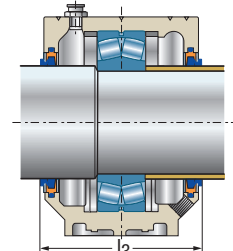

Filzstreifendichtung
SC..FS + V-Ring
V..A

Gehäuse	Dichtung ²	V-Ring ³	Enddeckel	Reglerscheibe				Festringe	
				w ₁	l ₁	l ₂	l ₃	Wälzlager	2 St. je Gehäuse
SNC230-530	SC230DS	V170A	SC230-530EC	65,0	236	294	256	22230	FR270x16,5
	SC230FS			76,5				23230	FR270x5
	SC230SV								
	SC230LA								
	SC230TA								
SNC232-532	SC232DS	V180A	SC232-532EC	70,5	251	309	271	22232	FR290x17
	SC232FS			82,5				23232	FR290x5
	SC232SV								
	SC232LA								
	SC232TA								

2. Dichtungen sind pro Gehäuseseite zu bestellen

3. V-Ring optional für Filzstreifenabdichtung (FS) erhältlich.

